

Female Header 1.27 mm

180° Series

SPECIFICATIONS

Current Rating: 1 A
 Insulator Resistance: 1000 MOhm min.
 Contact Resistance: 20 mOhm max.
 Dielectric Withstanding: AC 500 V
 Operating Temperature: -40°C ~ +105°C
 Soldering Temperature: 260°C for 3~5 sec. max
 Contact Material: Phosphor Bronze
 Insulator Material: Polyester, UL 94V-0
 Standard: Nylon-6T
 Finish: Tin, Gold or Duplex Plated
 Standard: Gold Flash all over
 Note: Duplex Plating: Gold Plated on contact area, Tin on solder area

F504-SGN-D024-XX

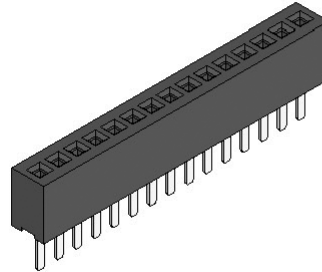

F604-SGN-D024-XX

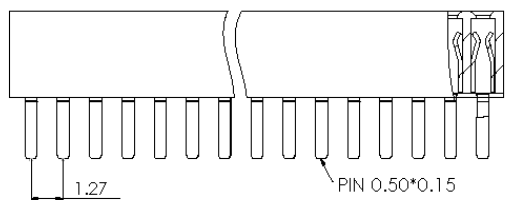
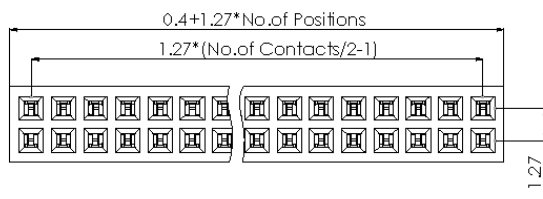
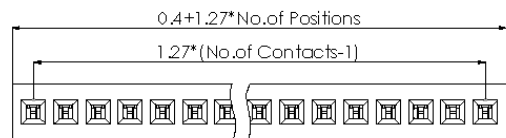
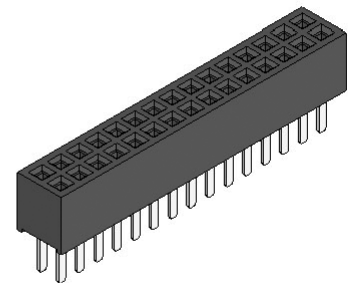

[F504]

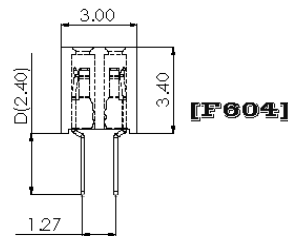
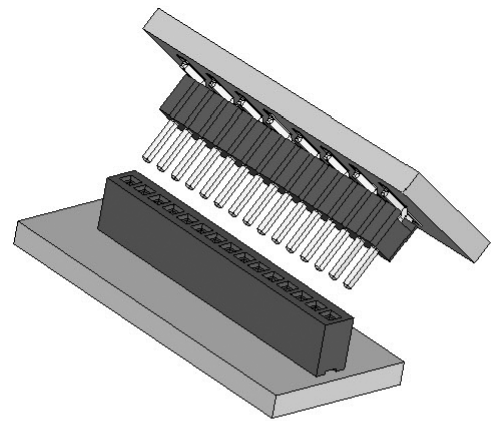
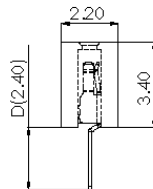

[F604]

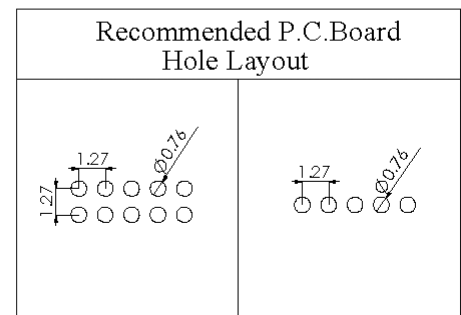

How to order

Unit: mm

Series	Connector Type	Contact Plating	Material	Pin Length mm	Number of Contacts
FXXX	X	X	X	DXXX	XX
F504: F/H 1.27 H: 3.40 Single Row F604: F/H 1.27 H: 3.40 Dual Row	S: Straight Type	G: Gold Flash T: Tin Plated A: 10U" Gold B: 15U" Gold C: 20U" Gold © Duplex Plating D: Gold Flash/Tin (Standard: G)	N: Nylon-6T (Standard: N)	S-D D024 (Standard: S-D024)	F504: (02 TO 40 Contacts) F604: (04 TO 80 Contacts)